

# ASSEMBLY INSTRUCTION

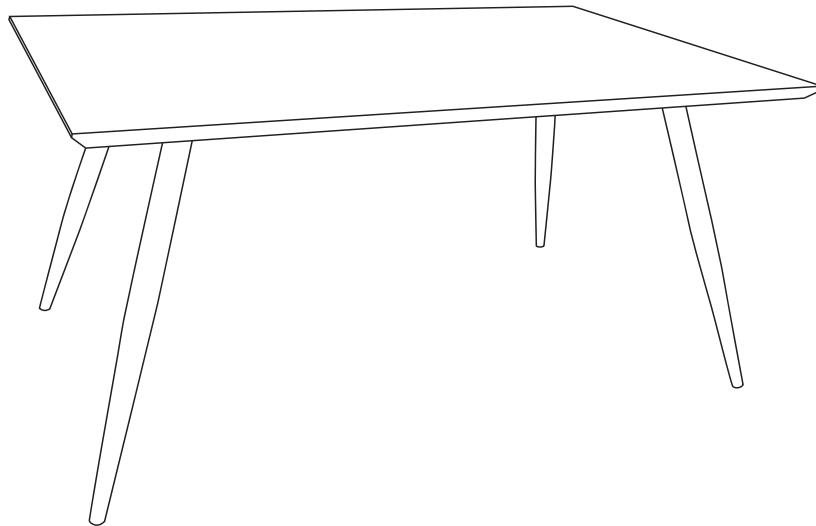

A X1

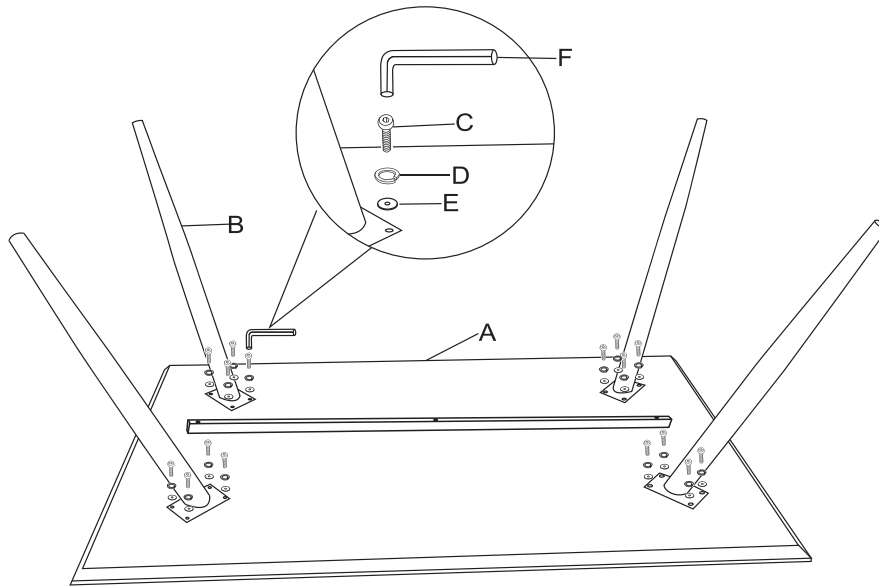

B X4



C X16



D X16



E X16



F X1

